

# Spezifikation für Freigabe / specification for release

Kunde / customer :

Artikelnummer / part number :

7443551730

LF



Bezeichnung : **SPEICHERDROSSEL WE-HCA**

description : **POWER-CHOKE WE-HCA**

DATUM / DATE : 2008-01-01

## A Mechanische Abmessungen / dimensions:

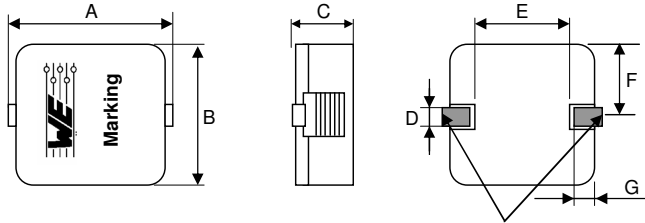

RDC is measured at these points

|   |                 |    |
|---|-----------------|----|
| A | 13,2 ± 1,0      | mm |
| B | 12,8 ± 0,5      | mm |
| C | 6,2 ± 0,3       | mm |
| D | 2,5 +1,0 / -0,5 | mm |
| E | 6,0 ± 0,5       | mm |
| F | 6,4 ± 0,5       | mm |
| G | 3,0 ± 1,0       | mm |

Marking = part number

## B Elektrische Eigenschaften / electrical properties:

| Eigenschaften / properties                | Testbedingungen / test conditions |                  | Wert / value | Einheit / unit | tol.  |
|---|-----------------------------------|------------------|--------------|----------------|-------|
| Lerrlaufinduktivität / initial inductance | 100 kHz / 0,1V                    | L <sub>0</sub>   | 7,30         | μH             | ± 20% |
| Nenn-Induktivität / rated inductance      | 100 kHz / 0,1V / 13,0A            | L <sub>N</sub>   | 5,00         | μH             | typ.  |
| DC-Widerstand / DC-resistance             | @ 20 °C                           | R <sub>DC</sub>  | 5,90         | mΩ             | ± 10% |
| Nennstrom / rated current                 | ΔT= 50 K                          | I <sub>N</sub>   | 13,0         | A              | typ.  |
| Sättigungsstrom / saturation current      | ΔL/L <sub>0</sub> = 30 %          | I <sub>sat</sub> | 12,0         | A              | typ.  |
| Eigenres.-Frequenz / self-res.-frequency  |                                   | SRF              |              | MHz            | typ.  |

## C Lötpad / soldering spec.:

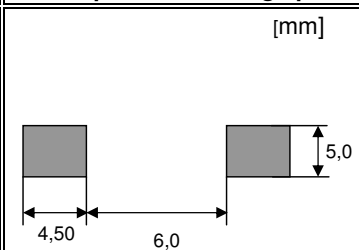

## D Prüfgeräte / test equipment:

WAYNE KERR 3260B für/for L<sub>0</sub>; R<sub>DC</sub>; I<sub>SAT</sub>; I<sub>N</sub>

## E Testbedingungen / test conditions:

Luftfeuchtigkeit / humidity: 33%  
Umgebungstemperatur / temperature: +20 °C

## F Werkstoffe & Zulassungen / material & approvals:

Basismaterial / base material: WE-Perm  
Draht / wire: AIW-100; Class H(200 °)

## G Eigenschaften / general specifications:

Arbeitstemperatur / operating temperature: -40 °C - +155 °C  
Umgebungstemp. / ambient temperature: -40 °C - +105 °C  
It is recommended that the temperature of the part does not exceed 155 °C under worst case operating conditions.

|                                     |                          |              |          |
|-------------------------------------|--------------------------|--------------|----------|
| Freigabe erteilt / general release: | Kunde / customer         |              |          |
|                                     |                          |              |          |
| Datum / date                        | Unterschrift / signature |              |          |
| Geprüft / checked                   | Würth Elektronik         |              |          |
|                                     |                          |              |          |
| Kontrolliert / approved             | ME                       | Version 4    | 08-01-01 |
|                                     | ME                       | Version 3    | 06-11-24 |
| Name                                | ME                       | Version 2    | 06-09-27 |
|                                     | Rst                      | Version 1    | 06-02-17 |
| Änderung / modification             |                          | Datum / date |          |

### Würth Elektronik eiSos GmbH & Co. KG

D-74638 Waldenburg · Max-Eyth-Strasse 1 - 3 · Germany · Telefon (+49) (0) 7942 - 945 - 0 · Telefax (+49) (0) 7942 - 945 - 400  
http://www.we-online.de

# Spezifikation für Freigabe / specification for release

Kunde / customer :

Artikelnummer / part number : **7443551730**

LF



Bezeichnung : **SPEICHERDROSSEL WE-HCA**

description : **POWER-CHOKE WE-HCA**

**WÜRTH ELEKTRONIK**

DATUM / DATE : 2008-01-01

## H Induktivitätskurve / Inductance curve:

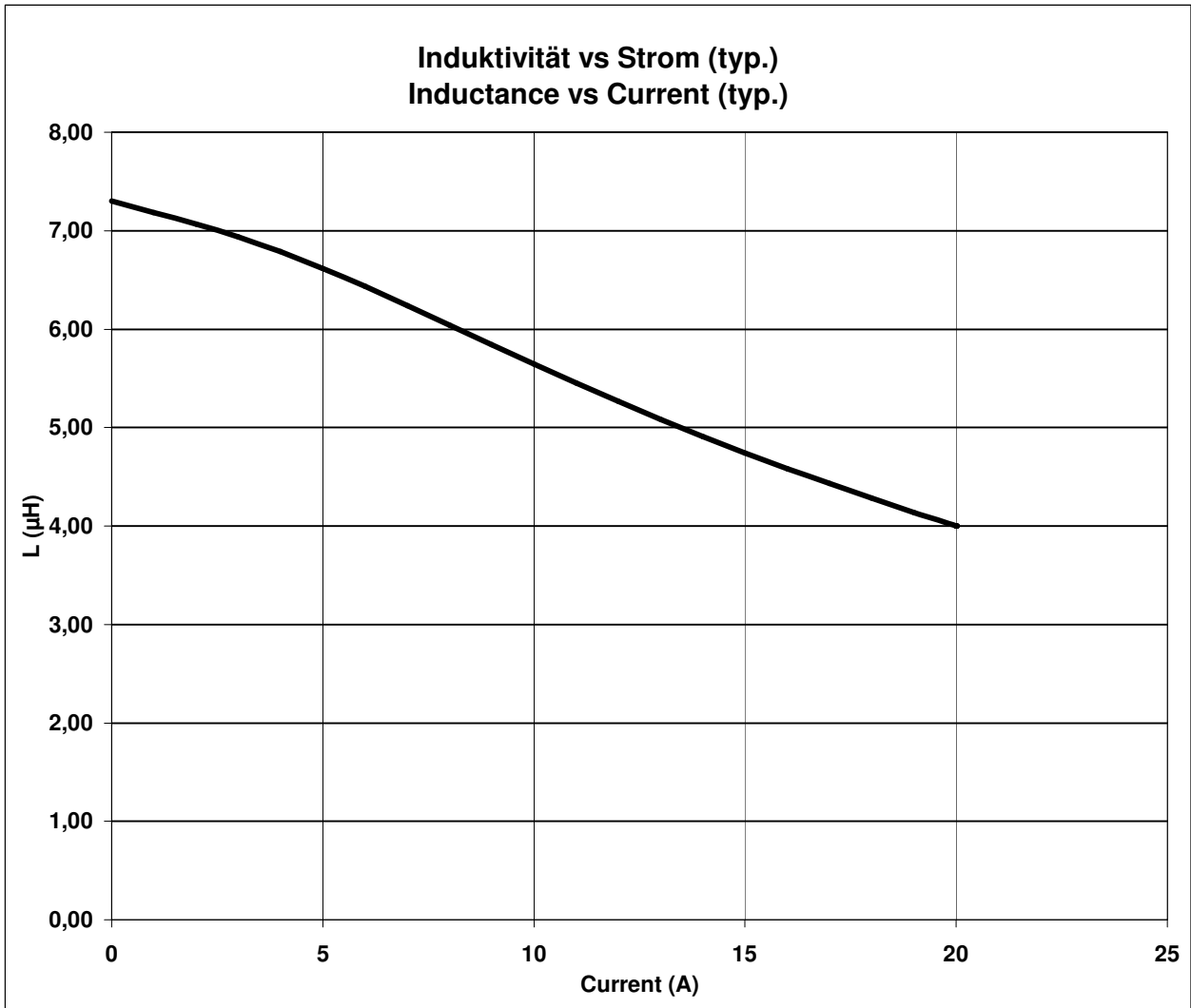

|                                     |                          |      |                                |              |
|-------------------------------------|--------------------------|------|--------------------------------|--------------|
| Freigabe erteilt / general release: | <b>Kunde / customer</b>  |      |                                |              |
| .....                               | .....                    |      |                                |              |
| Datum / date                        | Unterschrift / signature | ME   | Version 4                      | 08-01-01     |
| .....                               | .....                    | ME   | Version 3                      | 06-11-24     |
| .....                               | .....                    | ME   | Version 2                      | 06-09-27     |
| .....                               | .....                    | Rst  | Version 1                      | 06-02-17     |
| Geprüft / checked                   | Kontrolliert / approved  | Name | <b>Änderung / modification</b> | Datum / date |

### Würth Elektronik eiSos GmbH & Co. KG

D-74638 Waldenburg · Max-Eyth-Strasse 1 - 3 · Germany · Telefon (+49) (0) 7942 - 945 - 0 · Telefax (+49) (0) 7942 - 945 - 400  
http://www.we-online.de

# Spezifikation für Freigabe / specification for release

Kunde / customer :

Artikelnummer / part number : **7443551730**



Bezeichnung : **SPEICHERDROSSEL WE-HCA**

description : **POWER-CHOKE WE-HCA**

**WÜRTH ELEKTRONIK**

DATUM / DATE : 2008-01-01

## I Temperaturanstieg / Temperature rise curve:

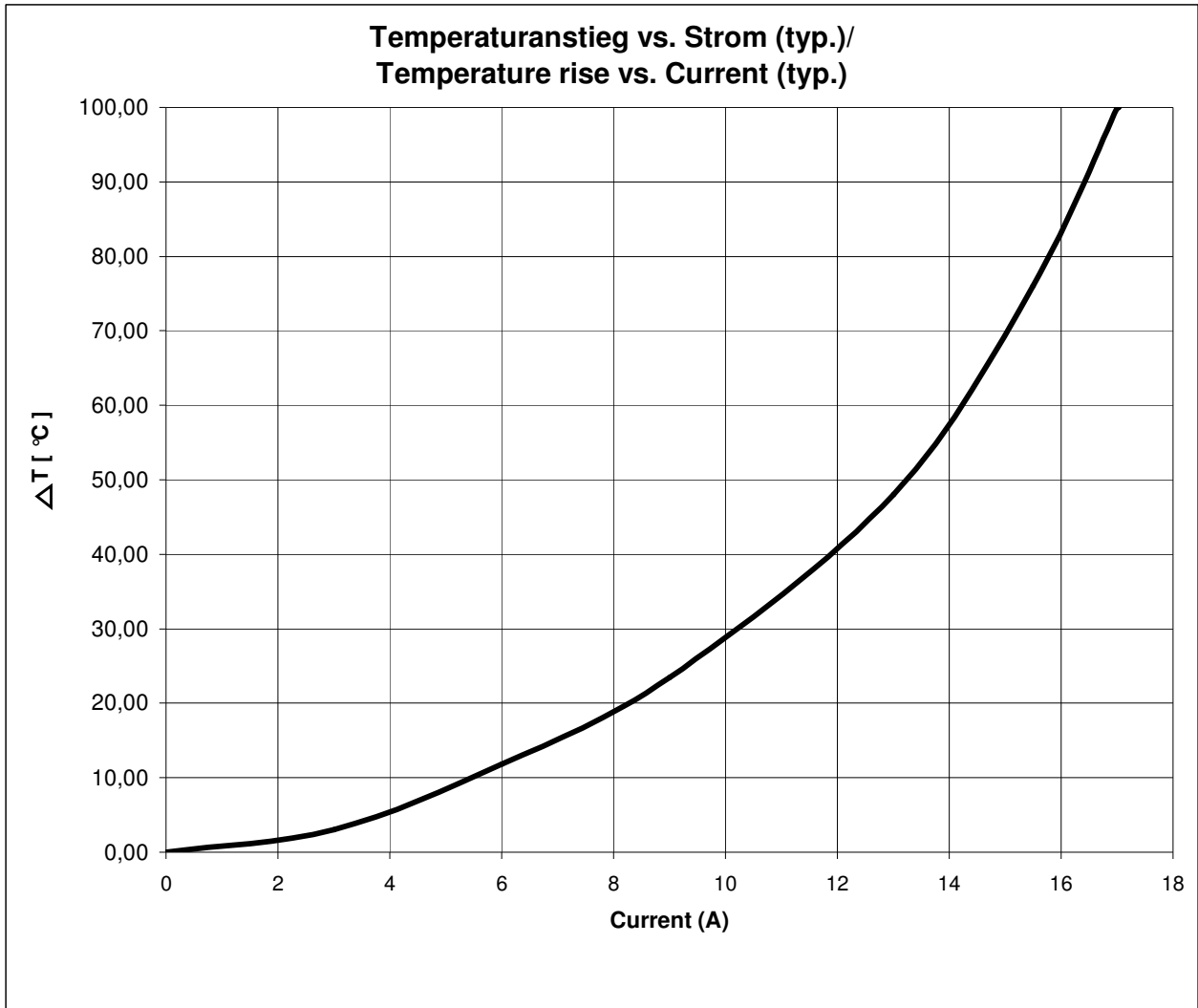

|                                     |                          |      |                                |              |
|-------------------------------------|--------------------------|------|--------------------------------|--------------|
| Freigabe erteilt / general release: | <b>Kunde / customer</b>  |      |                                |              |
|                                     |                          |      |                                |              |
| Datum / date                        | Unterschrift / signature | ME   | Version 4                      | 08-01-01     |
|                                     | <b>Würth Elektronik</b>  | ME   | Version 3                      | 06-11-24     |
|                                     |                          | ME   | Version 2                      | 06-09-27     |
|                                     |                          | Rst  | Version 1                      | 06-02-17     |
| Geprüft / checked                   | Kontrolliert / approved  | Name | <b>Änderung / modification</b> | Datum / date |

### Würth Elektronik eiSos GmbH & Co. KG

D-74638 Waldenburg · Max-Eyth-Strasse 1 - 3 · Germany · Telefon (+49) (0) 7942 - 945 - 0 · Telefax (+49) (0) 7942 - 945 - 400  
<http://www.we-online.de>

# Spezifikation für Freigabe / specification for release

Kunde / customer :

Artikelnummer / part number :

7443551730

LF



Bezeichnung : **SPEICHERDROSSEL WE-HCA**

description : **POWER-CHOKE WE-HCA**

DATUM / DATE : 2008-01-01

## I Rollenspezifikation / tape and reel specification:

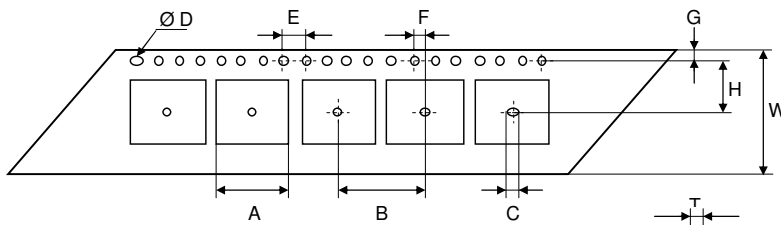

## Gurtspezifikation / Tape specification:

|   |                                      |    |
|---|--------------------------------------|----|
| A | 14,0 ± 0,1                           | mm |
| B | 16,0 ± 0,1                           | mm |
| C | 1,50 <sup>+0,1</sup> <sub>-0,0</sub> | mm |
| D | 1,50 <sup>+0,1</sup> <sub>-0,0</sub> | mm |
| E | 4,00 ± 0,1                           | mm |
| F | 2,00 ± 0,1                           | mm |
| G | 1,75 ± 0,1                           | mm |
| H | 11,5 ± 0,1                           | mm |
| I | 13,6 ± 0,1                           | mm |
| J | 6,80 ± 0,1                           | mm |
| T | 0,40 ± 0,05                          | mm |
| W | 24,0 ± 0,3                           | mm |

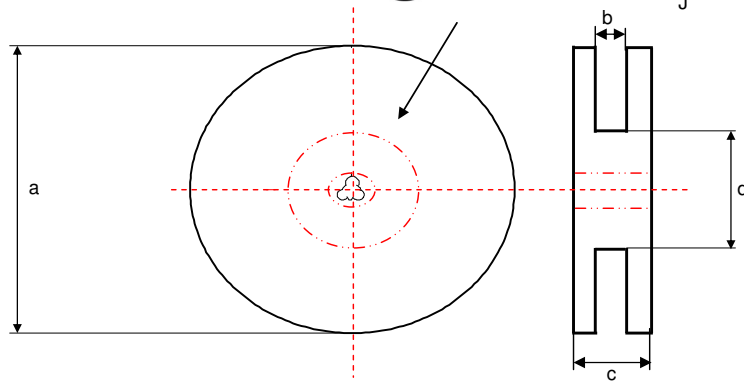

## Rollenspezifikation / Reel specification:

|   |             |    |
|---|-------------|----|
| a | 330,0 ± 2,0 | mm |
| b | 24,5 ± 0,8  | mm |
| c | 29,5 ± 0,5  | mm |
| d | 100,0 ± 1,5 | mm |

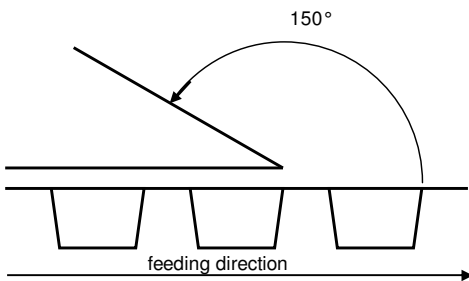

The Force for tearing off cover tape is 20 to 70 grams in arrow direction

Freigabe erteilt / general release:

|                   |                          |      |                                |              |
|-------------------|--------------------------|------|--------------------------------|--------------|
|                   | <b>Kunde / customer</b>  |      |                                |              |
|                   |                          |      |                                |              |
|                   |                          |      |                                |              |
| Datum / date      | Unterschrift / signature | ME   | Version 4                      | 08-01-01     |
|                   | <b>Würth Elektronik</b>  | ME   | Version 3                      | 06-11-24     |
|                   |                          | ME   | Version 2                      | 06-09-27     |
|                   |                          | Rst  | Version 1                      | 06-02-17     |
| Geprüft / checked | Kontrolliert / approved  | Name | <b>Änderung / modification</b> | Datum / date |

This electronic component has been designed and developed for usage in general electronic equipment. Before incorporating this component into any equipment where higher safety and reliability is especially required or if there is the possibility of direct damage or injury to human body, for example in the range of aerospace, aviation, nuclear control, submarine, transportation, (automotive control, train control, ship control), transportation signal, disaster prevention, medical, public information network etc, Würth Elektronik eiSos GmbH must be informed before the design-in stage. In addition, sufficient reliability evaluation checks for safety must be performed on every electronic component which is used in electrical circuits that require high safety and reliability functions or performance.

### Würth Elektronik eiSos GmbH & Co. KG

D-74638 Waldenburg · Max-Eyth-Strasse 1 - 3 · Germany · Telefon (+49) (0) 7942 - 945 - 0 · Telefax (+49) (0) 7942 - 945 - 400  
<http://www.we-online.com>